

TECHNICAL DATA

BASIC DATA

Rated voltage	12	V
20hr capacity at end voltage 1,75V/cell at 25°C	9	Ah
Internal resistance (fully charged battery) at 25°C	14	mΩ

DIMENSIONS

Length	151(±1)	mm
Width	65(±1)	mm
Height	94(±1)	mm
(Height with terminals)	99(±1)	mm
Weight	2,70	kg

TERMINALS

Faston	T2	-
--------	----	---

OPERATION TEMPERATURE RANGE

Storage	-15°C to +40°C
Charge	-15°C to +40°C
Discharge	-15°C to +50°C

STORAGE

Selfdischarge after 3 months at 20°C	10	%
Selfdischarge after 6 months at 20°C	20	%
Selfdischarge after 12 months at 20°C	40	%

CASE MATERIAL

Standard	ABS (UL 94:HB)
Flame retardant	ABS (UL94:V0)

CHARGE VOLTAGE

Float charge at 25°C	13,65 V ± 0,18 V
Cycle charge at 25°C	14,70 V ± 0,30 V

CHARGE CURRENT

Recommended	0,9	A
Maximum	2,70	A

MAX. DISCHARGE CURRENT

5 sec.	135	A
--------	-----	---

DESIGNED LIFE

BPower designed life at 25°C	up to 5	years
At 20°C according to Eurobat - General Purpose group	6 - 9	years

CYCLE LIFE

At 100% D.O.D.	200	cycles
At 50% D.O.D.	500	cycles

PHOTO



APPLICATIONS

- Uninterruptible Power Supplies (UPS)
- Telecommunication PABX
- Cash registers and fiscal printers
- Emergency lighting systems
- Emergency and fire systems
- Measure and mobile equipment
- Lawn mowers and electric bikes
- Toys

SAFETY



DISCHARGE CHARACTERISTICS

• Constant current (Current [A], 25 [°C])

F.V. V/cell	Discharge time										
	5 min	10 min	15 min	30 min	1h	2h	3h	4h	5h	10h	20h
1,85	29,8	18,7	14,0	7,93	5,07	2,58	2,08	1,66	1,43	0,810	0,418
1,80	31,9	20,0	14,6	8,28	5,18	2,67	2,14	1,71	1,48	0,824	0,435
1,75	34,3	21,5	15,5	8,75	5,26	2,72	2,19	1,73	1,50	0,838	0,450
1,70	36,0	22,4	16,2	9,16	5,34	2,78	2,22	1,76	1,52	0,849	0,452
1,65	37,7	23,6	17,0	9,57	5,41	2,83	2,26	1,78	1,54	0,859	0,455
1,60	39,5	24,7	17,6	10,0	5,46	2,87	2,29	1,79	1,55	0,866	0,457

• Constant power (Power [W/cell], 25 [°C])

F.V. V/cell	Discharge time										
	5 min	10 min	15 min	30 min	1h	2h	3h	4h	5h	10h	20h
1,85	56,0	35,8	29,5	15,5	9,77	5,29	4,12	3,33	2,83	1,59	0,836
1,80	59,0	38,3	30,6	15,9	10,2	5,45	4,26	3,46	2,93	1,65	0,864
1,75	63,4	41,2	31,7	16,7	10,5	5,58	4,40	3,56	2,99	1,68	0,884
1,70	66,4	43,1	32,7	17,3	10,8	5,70	4,53	3,66	3,04	1,72	0,889
1,65	69,8	45,2	34,0	17,6	11,1	5,78	4,66	3,77	3,09	1,74	0,895
1,60	73,2	48,0	35,2	18,7	11,3	5,83	4,75	3,84	3,12	1,76	0,900

F.V. - Final Voltage

DIMENSIONS/TERMINALS

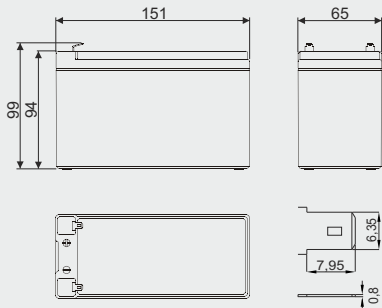

DISCHARGE CHARACTERISTICS

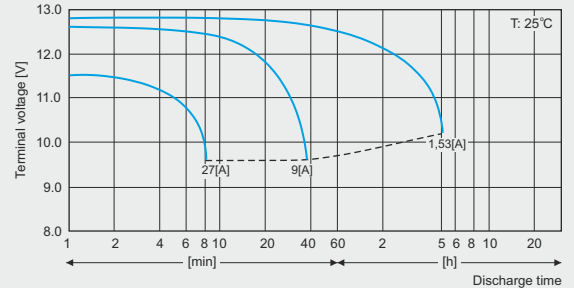

CHARGE CHARACTERISTICS

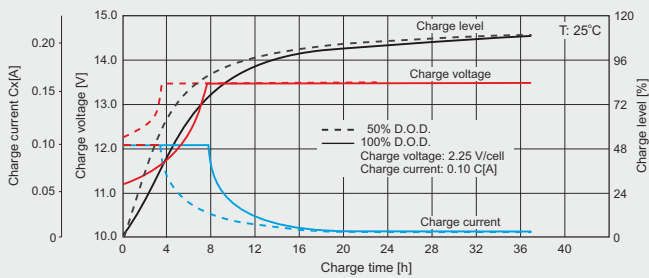

FLOAT LIFE

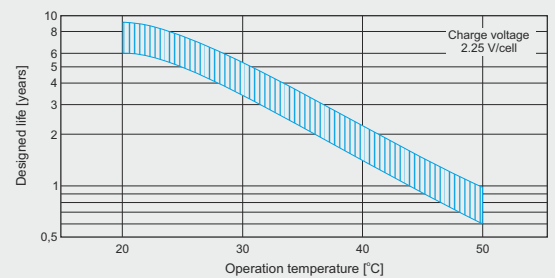

CYCLIC LIFE

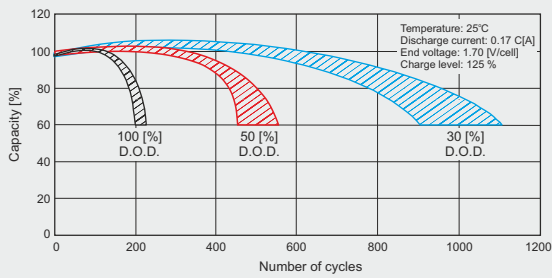

CAPACITY VS. TEMPERATURE

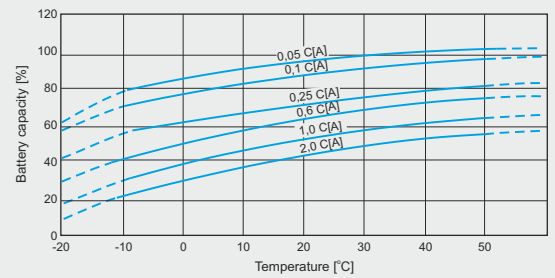

SELFDISCHARGE CHARACTERISTICS

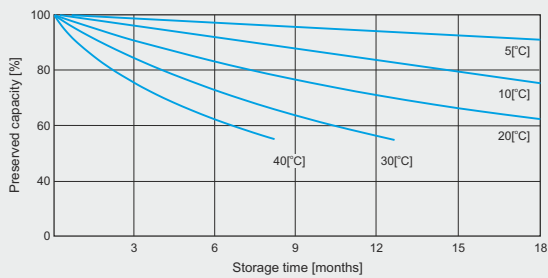

ENVIRONMENTAL INFORMATION

EXPLOITED BATTERIES ARE CONSIDERED AS HAZARDOUS WASTE. THESE WASTES DUE TO THEIR ORIGIN, CHEMICAL COMPOSITION (THEY CONTAINS HEAVY METALS LIKE LEAD AND OTHER TOXIC SUBSTATIONS) AND OTHER FEATURES MAY BE DANGEROUS FOR ENVIRONMENT AND HUMAN OR ANIMAL HEALTH AND LIFE.